





Ø8 × 35		Ø8 × 24					
A 18×	B 8×	C 8×	D 8×	E 8×	F 4×	G 4×	H 4×
							
Ø8 × 27			Ø3,5 × 16				
I 4×	J 4×	K 1×	L 20×	M 2×			



1



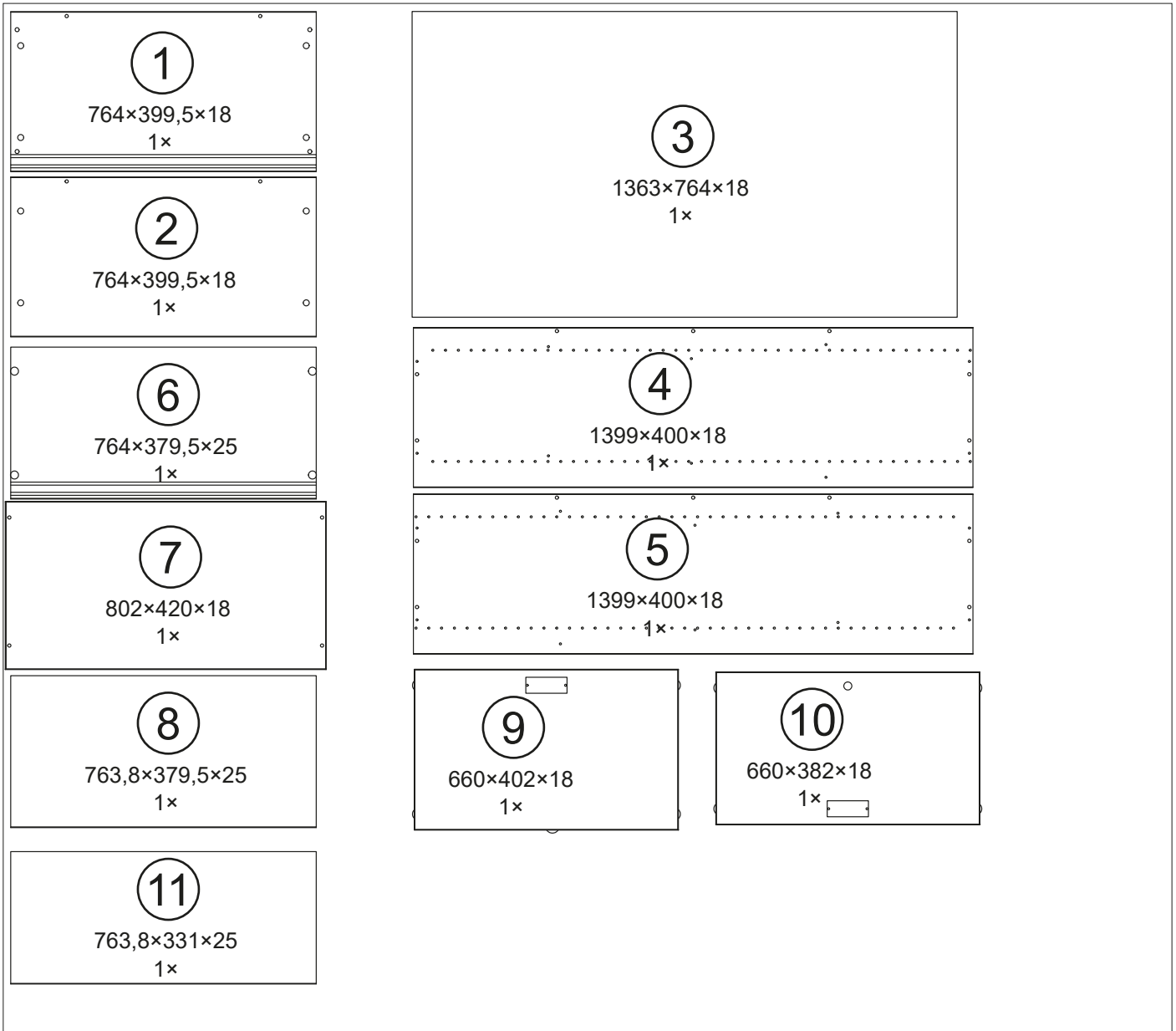
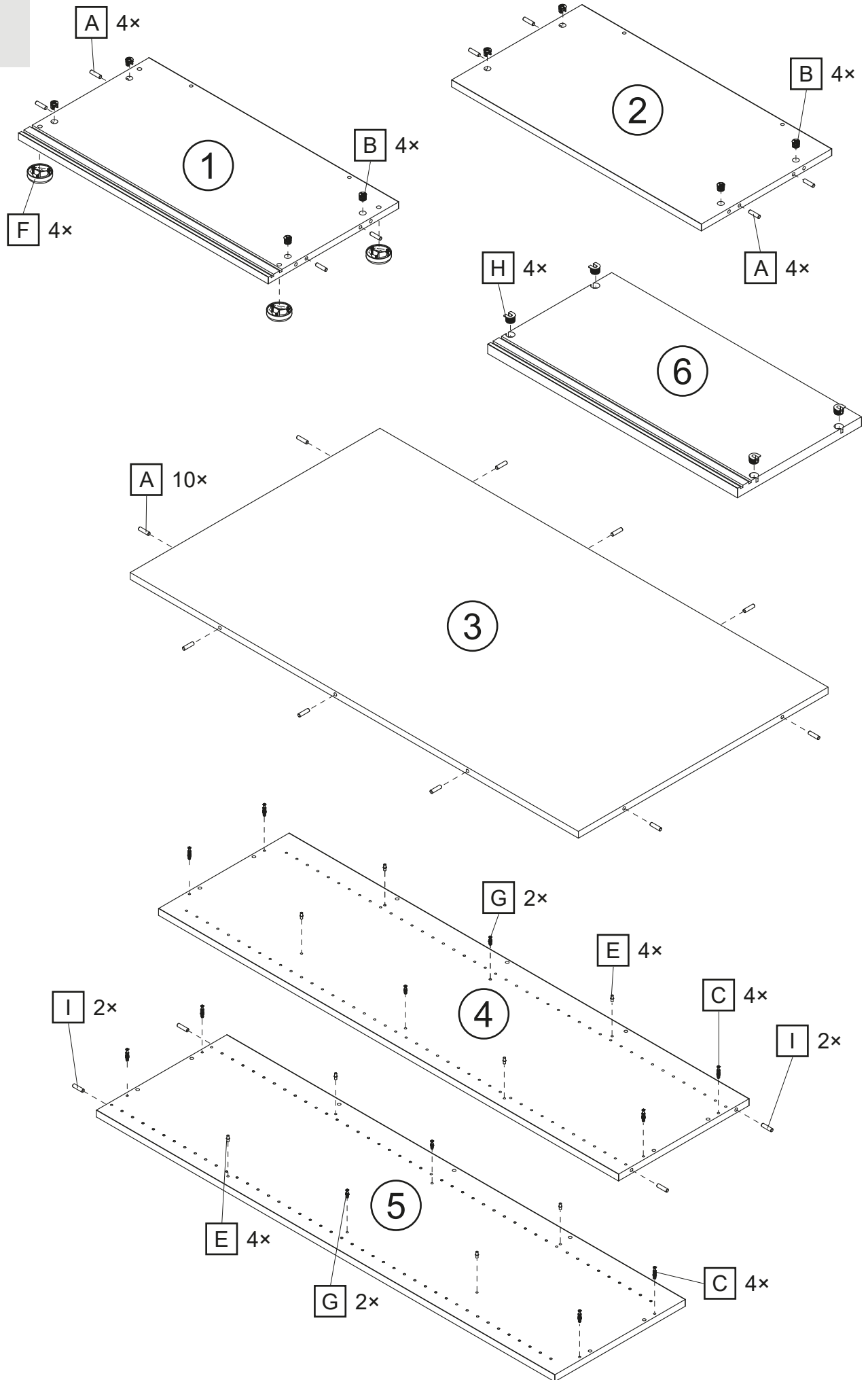
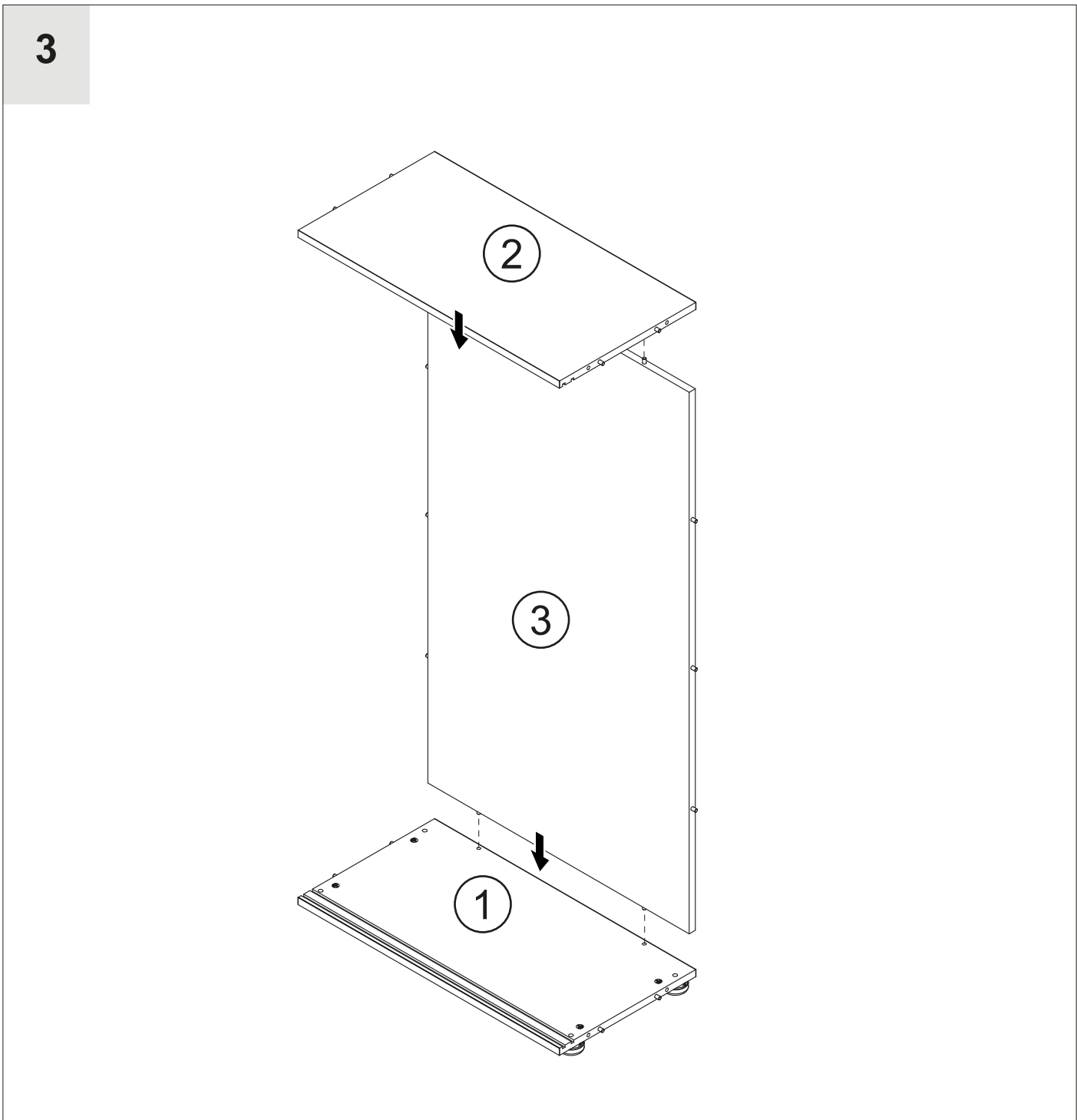
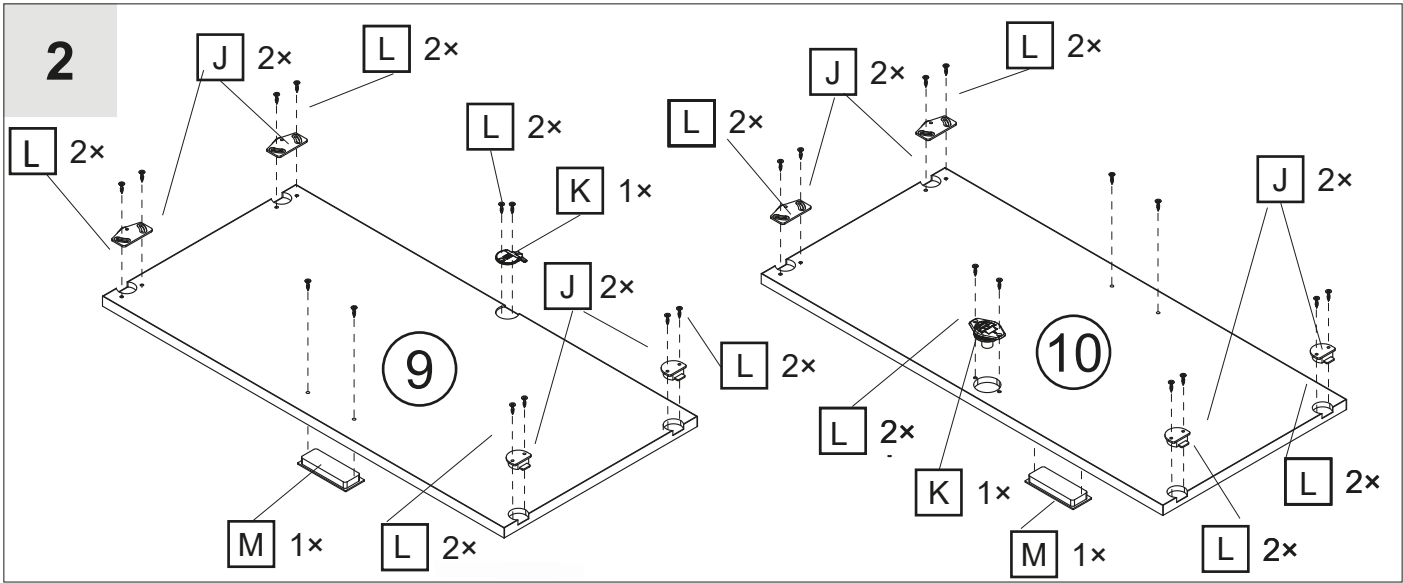

4

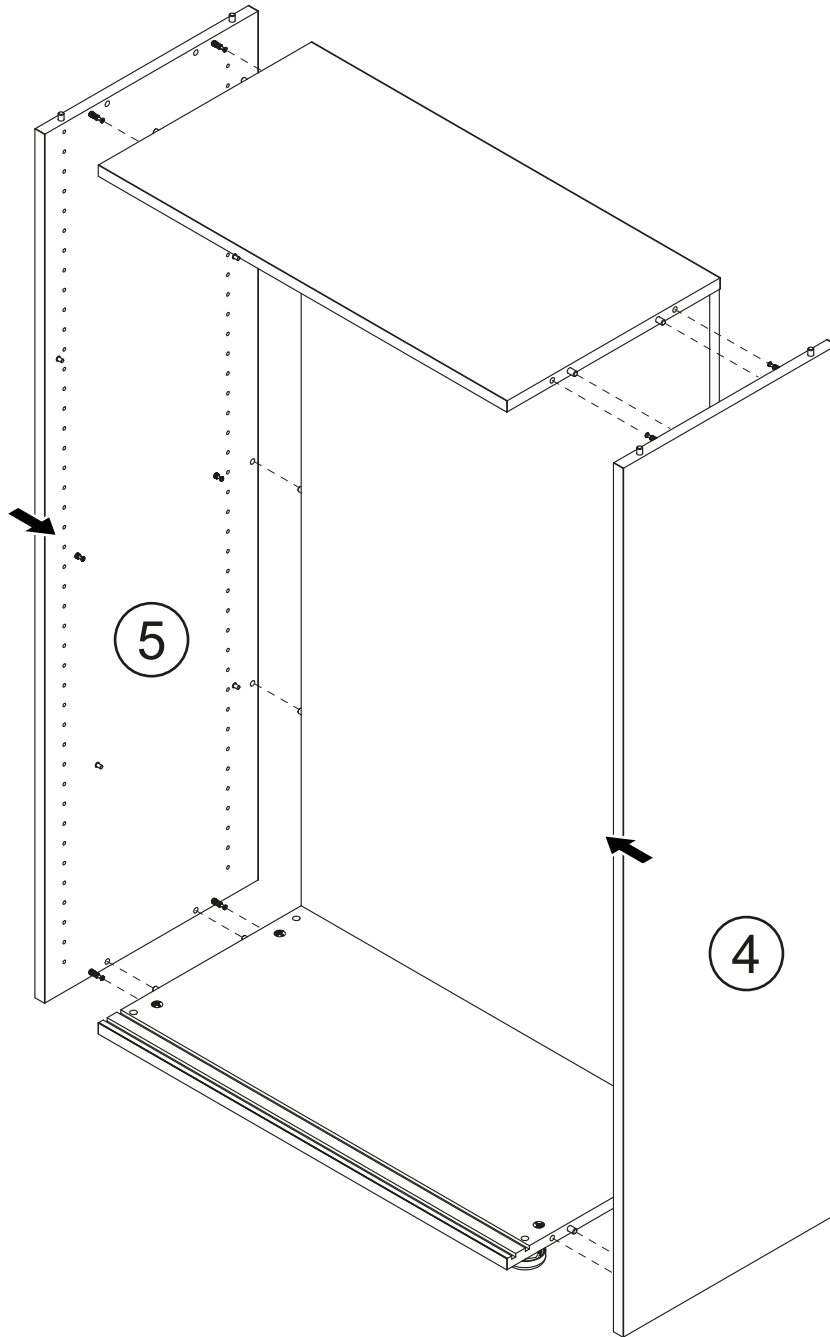

5

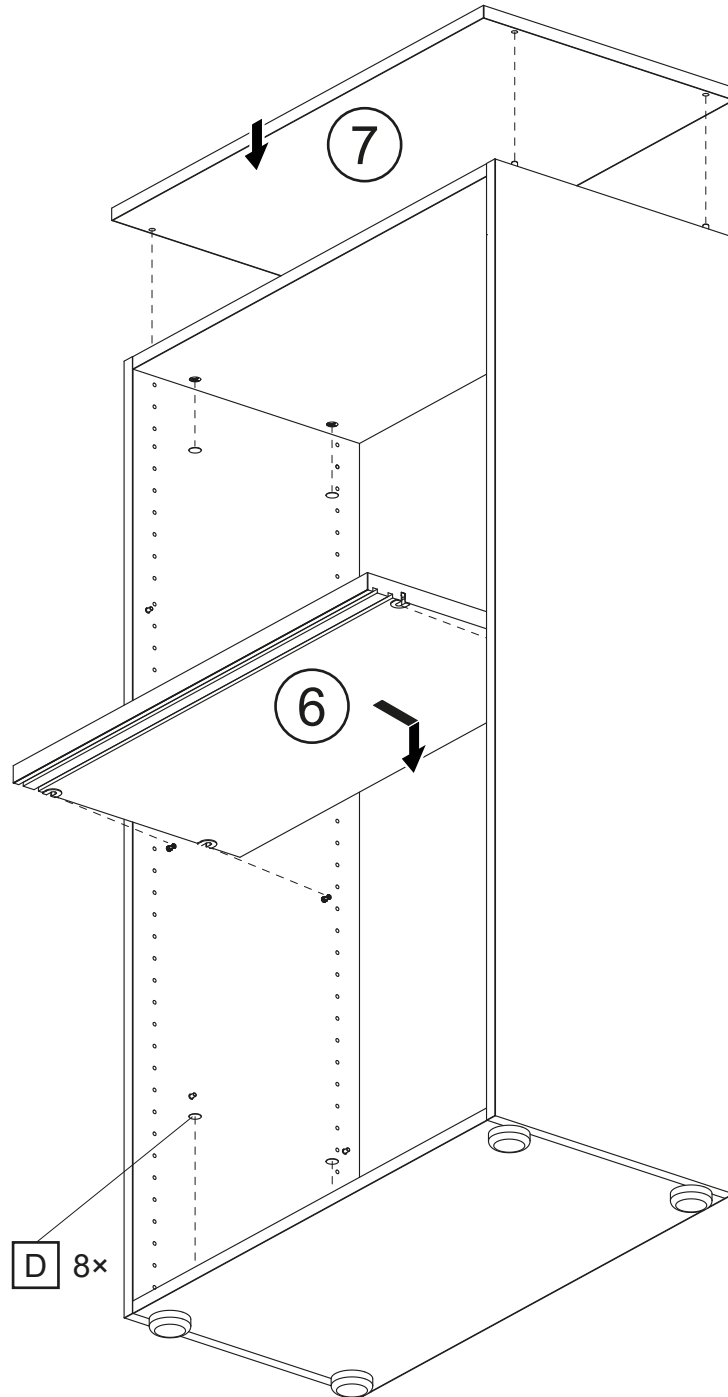

6

